

**dli**

# **DLI 8500P** Vehicle Mount Terminal

## Product Manual

## **Disclaimer**

Data Ltd., Inc. (DLI) reserves the right to make changes in specifications and other information contained in this document without prior notice, and the reader should in all cases consult DLI to determine whether any such changes have been made. The information in this publication does not represent a commitment on the part of DLI.

DLI shall not be liable for technical or editorial errors or omissions contained herein: nor for incidental or consequential damages resulting from the furnishing performance, or use of this material.

This document contains proprietary information that is protected by copyright. All rights are reserved. No part of this document may be photocopied, reproduced, or translated into another language without the prior written consent of DLI.

© 2011 Data Ltd., Inc. All rights reserved.

Web Address: [www.data ltd.com](http://www.data ltd.com)

## **Trademarks**

DLI 8500P is a trademark or registered trademark of Data Ltd., Inc.

Windows XP, Windows Embedded Standard, Windows Tablet PC, Windows 7, and the Windows logos are trademarks or registered trademarks of Microsoft Corporation.

The Bluetooth trademarks are owned by Bluetooth SIG, Inc., USA and licensed to DLI

The Adaptus trademark is owned by Honeywell Corporation, and licensed to DLI

The Symbol & Motorola trademarks are owned by Motorola Corporation, USA and licensed to DLI

The PenMount trademarks are owned by PenMount International Corp. and licensed to DLI  
Other product names mentioned in this manual may be trademarks or registered trademarks of their respective companies and are hereby acknowledged.

## Table of Contents

Thank You! .....	4
DLI 8500P Peripherals and Accessories .....	4
Hardware Overview .....	5
Setting Up the DLI 8500P Terminal .....	8
Unpack the Carton and Verify its Contents .....	9
Battery Status LED's .....	9
Charging the Battery in the DLI 8500P .....	9
Power Management Utility.....	11
Optional Auto Power On & Off Setup .....	11
Adjusting the Backlight .....	12
Using the Stylus.....	13
Using the Programmable Keys.....	16
Using the WiFi Radio .....	19
Using the Bluetooth Radio.....	22
Using the Camera Option .....	25
Using the RS-232 DB9M .....	26
Using the GPS .....	27
Installing Clearance & Airflow.....	29
Integrated Power Filtering DC Converter .....	29
Technical Assistance.....	29
Product Service and Repair.....	29
Shipping your DLI Device .....	30
Limited Warranty.....	32
Regulatory and Safety Approvals .....	33
FCC Compliance .....	35

## **Thank You!**

Data Ltd Inc. would like to thank you for selecting the DLI 9200. The DLI 9200 was designed as a forward thinking product that is modular in design and upgradeable. We thank you, the customer, for giving us the inspiration for the following features:

- Impact Resistant Case
- Integrated Backup Battery with 10~60V DC/DC Converter
- Integrated four radio technology (WiFi, Bluetooth, GPS, and Cellular)
- 10" Industrial-rated touchscreen
- Dual internal WiFi antennas and internal Bluetooth antenna
- Boot media via SSD (Solid State Drive)

## **DLI 8500P Peripherals and Accessories**

5421112020900P	AC Adapter with Line Cord.
6705200041000P	Cigarette Lighter Adapter for charging the unit in a vehicle.
4104033000002P	Handle

## Hardware Overview

### Front Panel

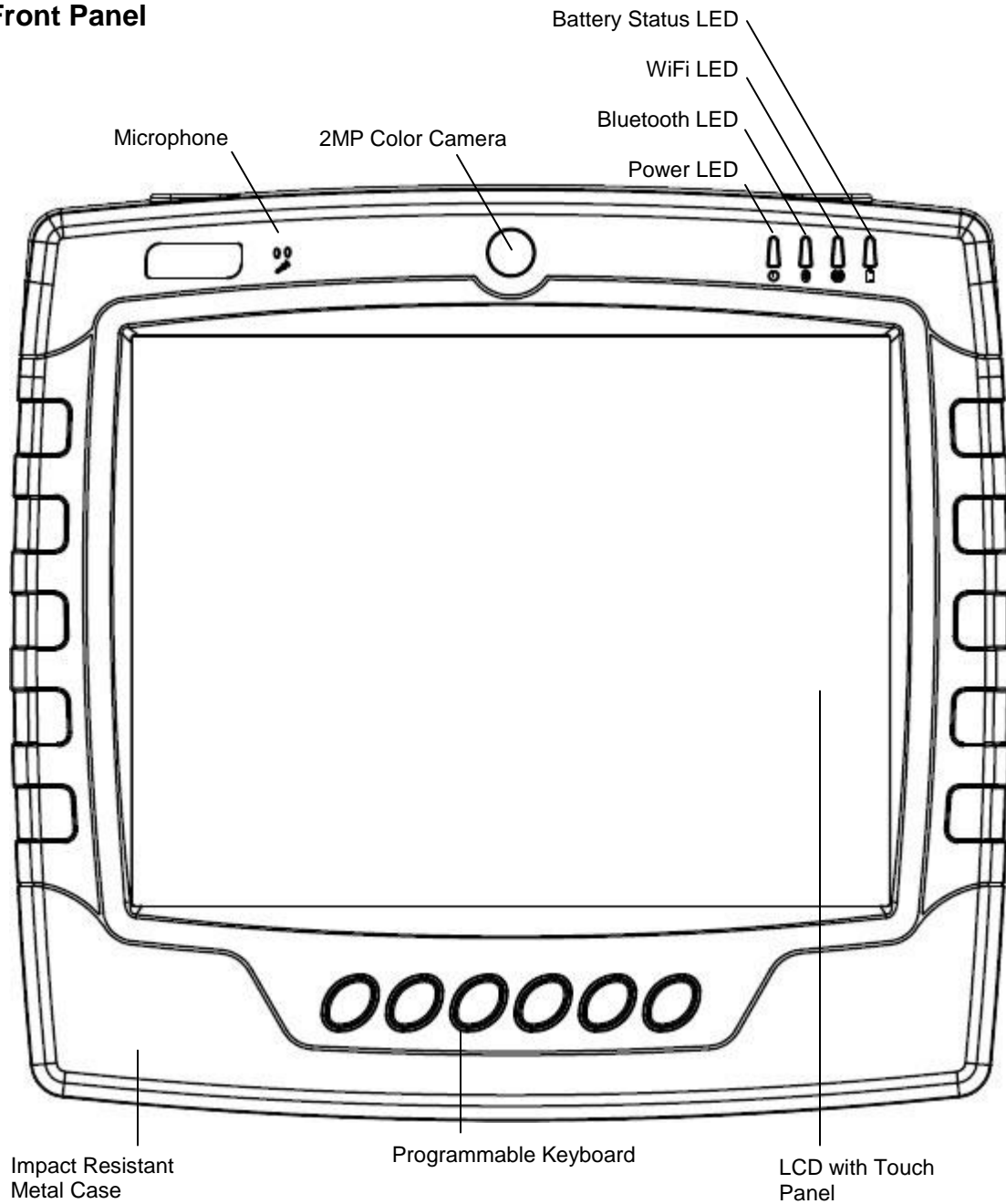

## Front Panel Status Indicator Lights

The front panel includes status indicator lights for the following:

- Power On / Off
- Bluetooth
- WiFi
- Battery

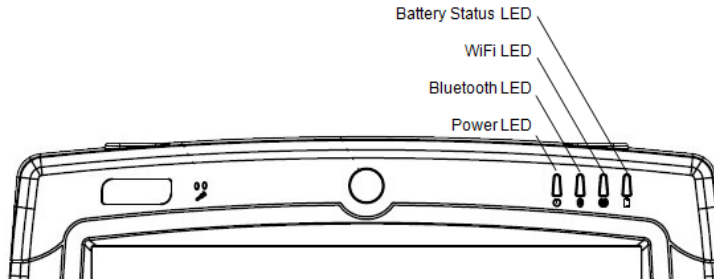

Indicator Light	Status	Description
Power	Solid Green	Powered On
Bluetooth	Blinking Blue	Enabled
	No Light	Disabled or Not Available
WiFi	Green Light	Connected
	No Light	No Connection
Battery Status		Refer to Battery Status LED section. Page 9

## Bottom Panel

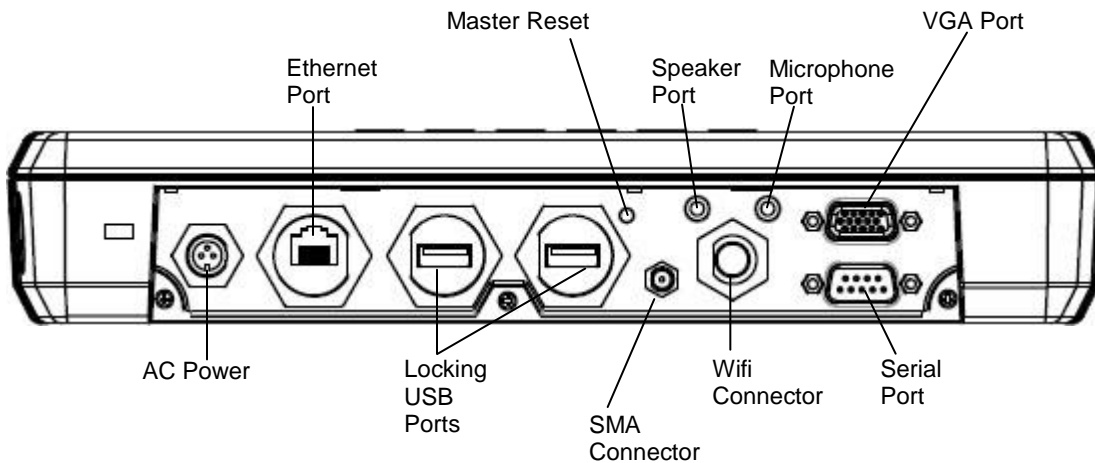

## Bottom Panel Features

- Master Reset button. This forces a hard reset.
- Standard Ethernet Port (RJ-45)
- Standard Serial Port (RS-232 DB9) See Page 26.
- Standard Audio Ports (Speaker and Microphone Port)
- VGA Port (Video Out)
- Optional SMA Connector for External GPS
- Optional External FME Antenna Connector
- Standard locking USB, industrial grade connectors. Only DLI authorized peripherals should be attached to these USB ports. The USB port power is rated to 1A.

### USB Port

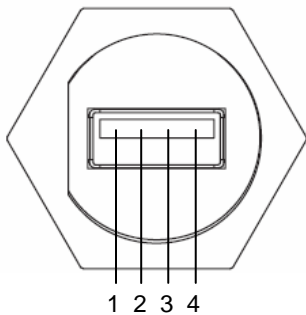

Pin #	Description
1	(+5V)
2	Data +
3	Data -
4	GND

## Side Panel

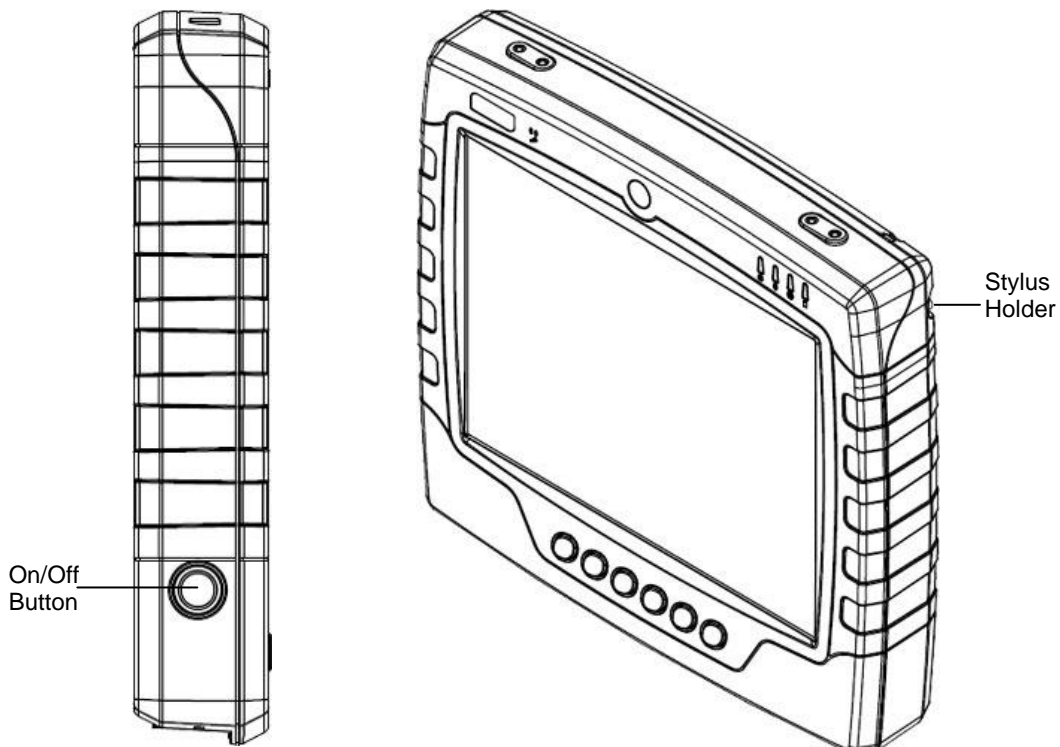

## Back Panel

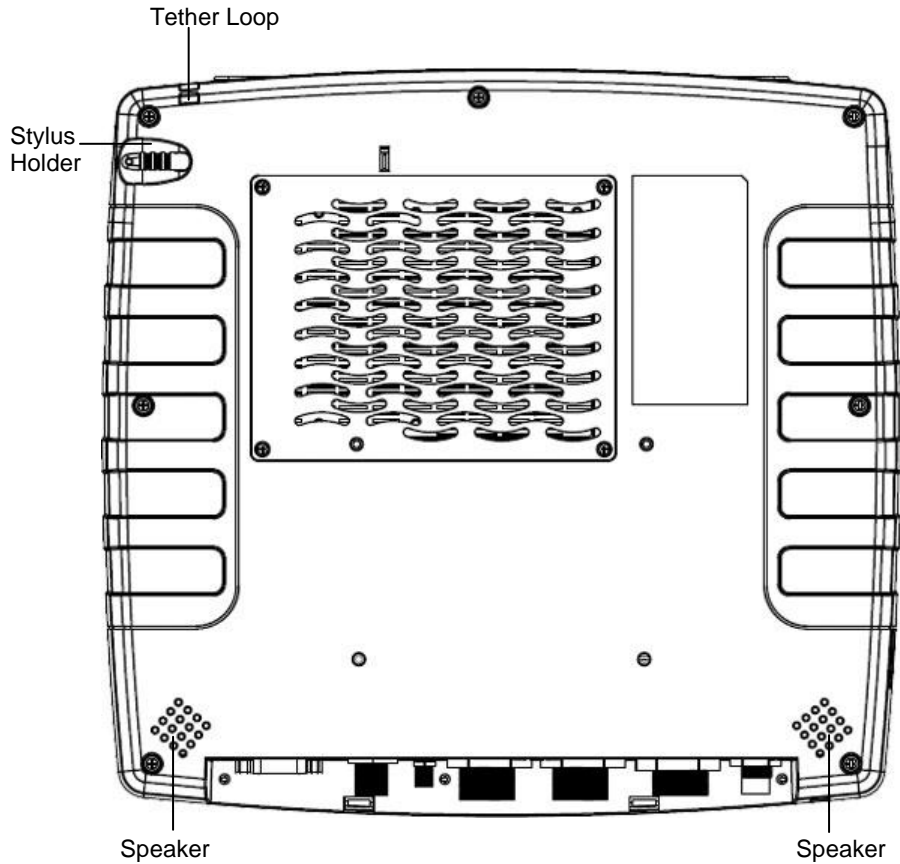

## Setting Up the DLI 8500P Terminal

1. Unpack the carton and verify its contents. – Page 9
3. Charge the main battery for 2hrs.
4. Power on the terminal via the power button on the left side of the terminal.
5. Let the device load and end on the Desktop screen.



*Default BIOS password is **qwerty***

## Unpack the Carton and Verify its Contents

Verify that the carton contains the following items:

- DLI 8500P Industrial Tablet Computer (terminal)
- DLI 8500P Quick Reference Start Guide



*If you ordered peripherals and/or accessories, verify that they are also included with the order.*

Be sure to keep the original packaging in case the DLI 8500P needs to be returned for service— See page 30.

## Battery Status LED's

### On Power Source (Charger)

Battery Indicator Light	Status	Description
Power	Solid Green	Powered On
Battery	Solid Green	Capacity level = 100%
	Blinking Green	Capacity level > 70%
	Blinking Yellow	Capacity level > 20% - < 70%
	Blinking red	Capacity level < 20%

### Off Power Source (No Charger)

Battery Indicator Light	Status	Description
Power	Solid Green	Powered On
Battery	Solid Green	Capacity level > 70%
	Solid Yellow	Capacity level < 70% - > 20%
	Solid Red	Capacity level < 20% - > 10%
	Blinking red	Capacity level < 10%



**For charging, use only Data Ltd. Inc., DLI 8500P peripherals and the power cables. Use of peripherals or cables not sold/manufactured by Data Ltd will void the warranty and may damage the terminal.**

## Charging the Battery in the DLI 8500P

1. Connect the DLI 8500P to the power supply provided by Data Ltd.
2. The battery will begin charging immediately
3. Charge the battery for two hours, then power on the terminal.



**Due to the nature of Lithium Ion, be sure to periodically charge your batteries, as months of inactivity can have a long-term negative effect on the life of the battery.**



*The battery will charge even if the terminal is in use as long as AC is applied to the terminal.*

## Checking the Battery Power

The main way to check the battery power on the DLI 8500P is to use the battery icon. It provides a graphical representation of the remaining battery power.

- Tap on the battery icon in the system task bar.



- Tapping the battery icon once will show the battery life percentage and default / premade Power Plans.

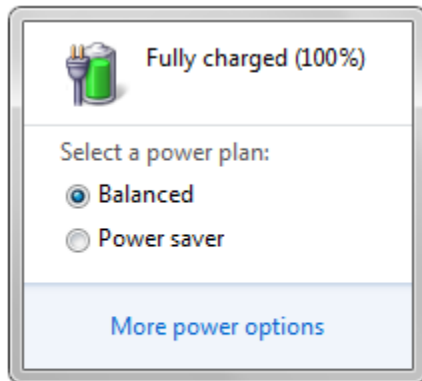

## Power Management Utility

The DLI 8500P includes a comprehensive suite of power management functions. The power management is based upon the ACPI Standard (Advanced Configuration and Power Interface Specification) and is operated within the Embedded Controller (EC) at low level management. A graphical interface is supplied so that customer specific power plans can be controlled. The Power Management Utility is accessible from the DLI Control Center application as well as from the **control panel** within Windows.

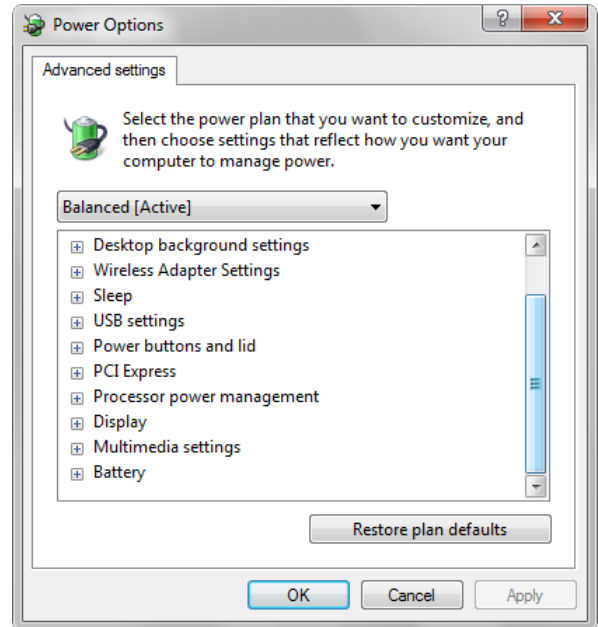
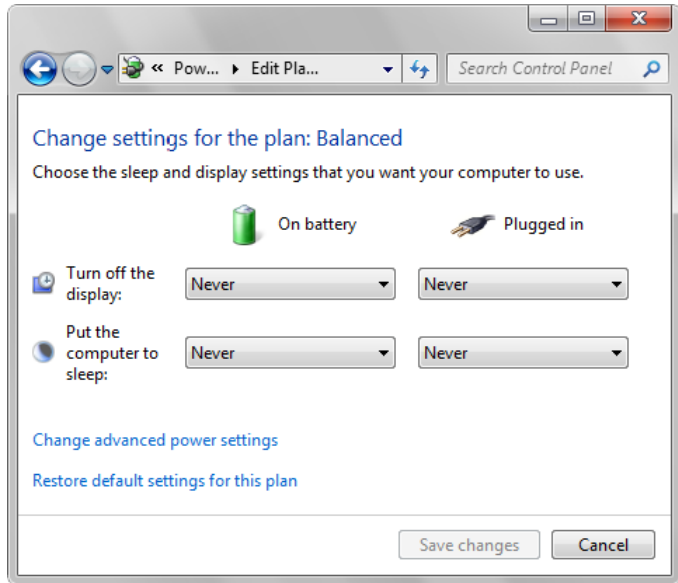

## Optional Auto Power On & Off Setup

Your device can be set to power on when external power is detected via the BIOS and powered off at a certain battery percentage via the Operating System.

To enable the Auto Power On feature please contact DLI Technical Support, 800.526.1299 x774.

To enable the Auto Power Off feature based on battery percentage:

Tap Start>Control Panel>Power Options.

Select Change Plan Settings under the current Power Plan. This will bring up the Sleep and Display settings (shown above on the left). Now select Change Advanced Power Settings (shown above on the right).

(Continued on page 12)

Select Battery to expand the options (shown below).

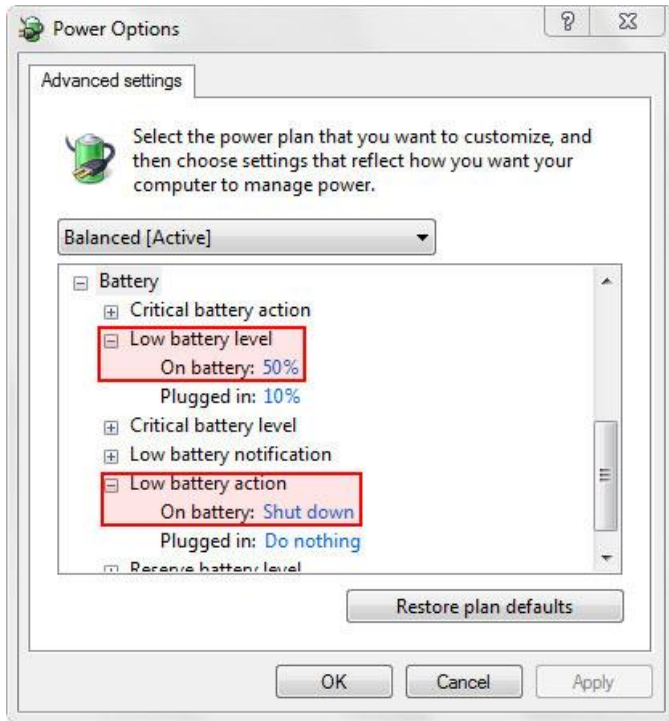

Select **Low battery level** and give the **On battery** a percentage. 50% is what is shown; this number can be changed to better fit the needed requirements.

After selecting a low battery level, now select a **Low battery action**. Select **Shut down** for **On Battery**. Select Apply and OK.

Once external power is removed (ie. a forklift or a vehicle is turned off) the device will run off the internal battery until it reaches the Low battery level set above and perform the set action.

## Adjusting the Backlight

Brightness levels of the liquid crystal display (LCD) are adjustable based on the lighting conditions. By default the level is set to 7. (0 being the lowest and 7 being the highest level) To adjust the level of backlight:

Start>Control Panel. Choose the DLI Brightness icon.



Tap “-” or “+” to adjust the brightness. The settings are **auto saved** after adjustment. Tap *Options>Place in system tray for quick access to this utility.*

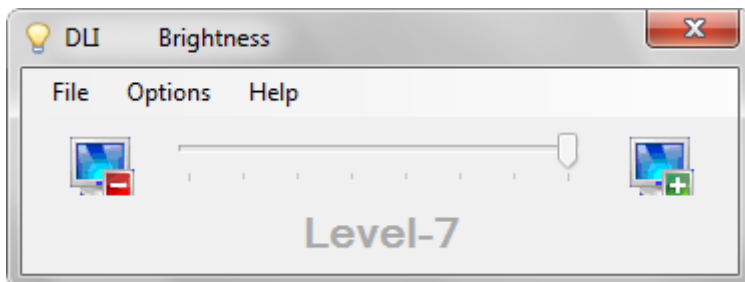

## Using the Stylus

### Calibrating and Using the Stylus

Calibration ensures the accuracy of the stylus and adjusts the input angle for each person who uses it. The terminal stores calibration data and settings on a per-user basis.

The stylus functions as a mouse; generally, a tap is the same as a mouse click.

- Tap:** Tap the touch screen once to open menu items and select options.  
**Drag:** Hold the stylus on the screen and drag across the screen to select text and images. Drag in a list to select multiple items.  
**Right Mouse Click:** Holding down the stylus for 3 seconds will activate the right mouse click.

#### Calibration:

1. Right tap on the PenMount icon in the system tray.



2. Select the PenMount Control Panel.

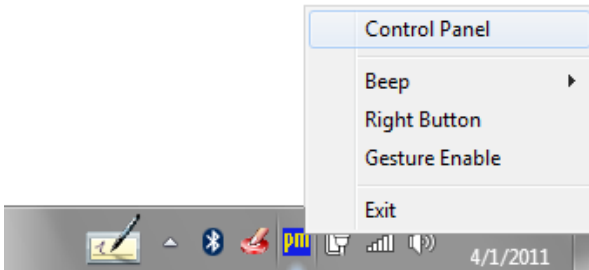

3. Chose the PenMount 6000 USB icon and tap the Configure button.

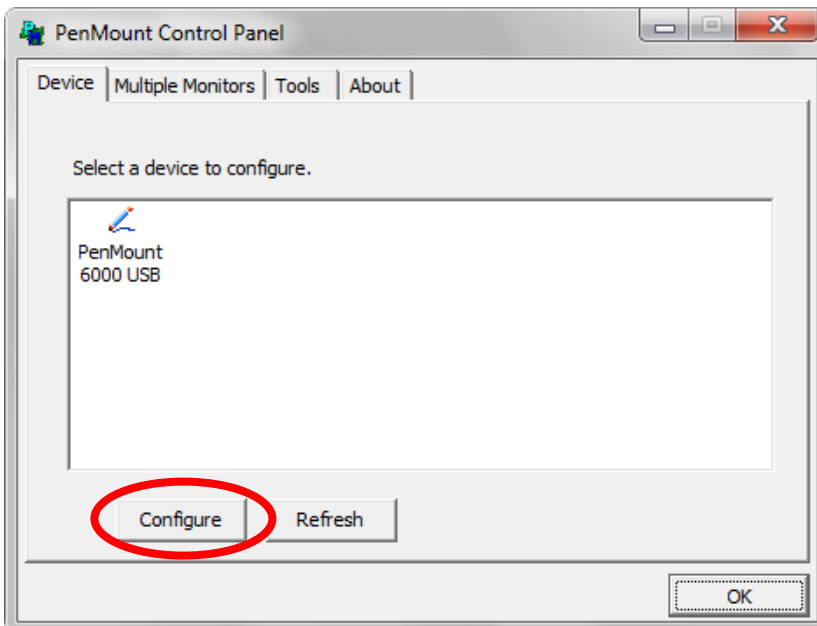

4. Tapping on the Calibration button will prompt the user to tap multiple points on the screen.

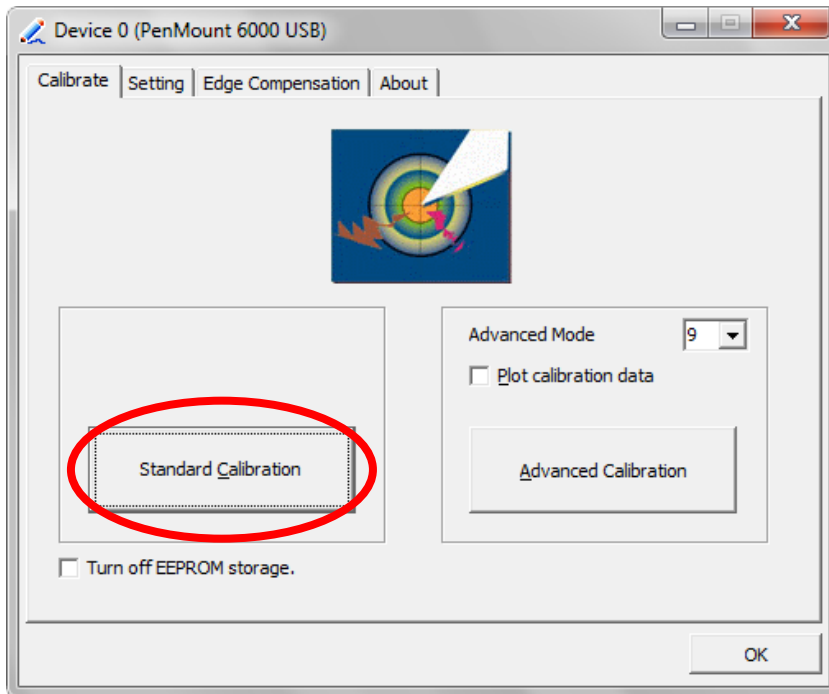

5. Hold the stylus naturally as if you were writing with a ball point pen, holding the stylus down on each red point as they appear. During calibration, position the terminal as close to the way you would use it.

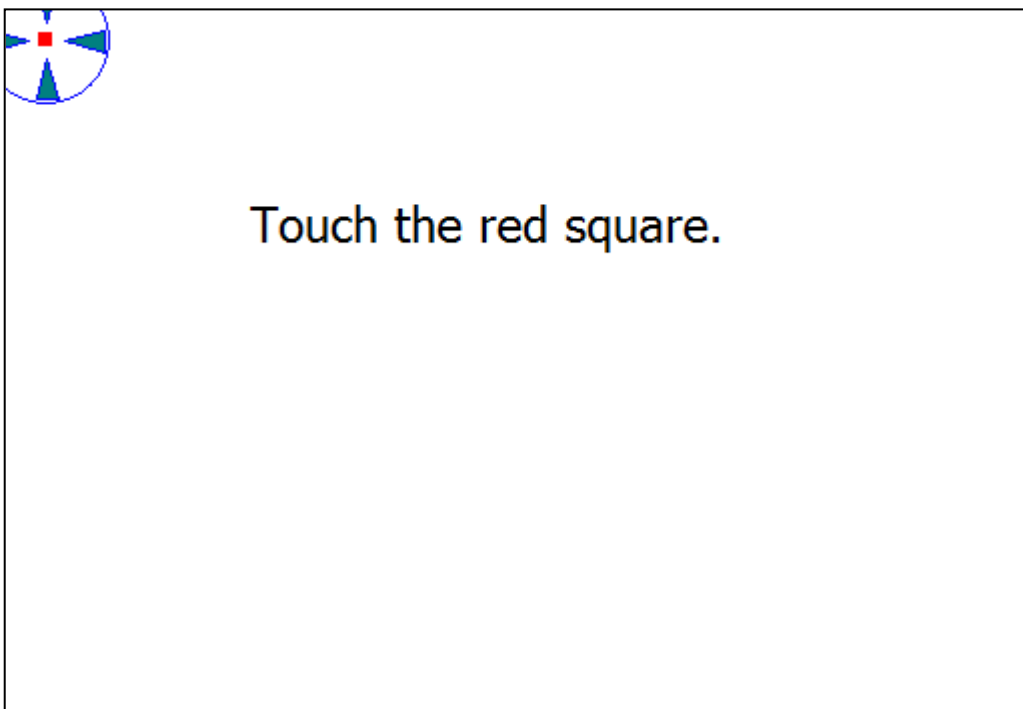

6. After completion the screen returns to the Standard Calibration window. Selecting OK will save the settings. Tapping Standard Calibration will start the process again.

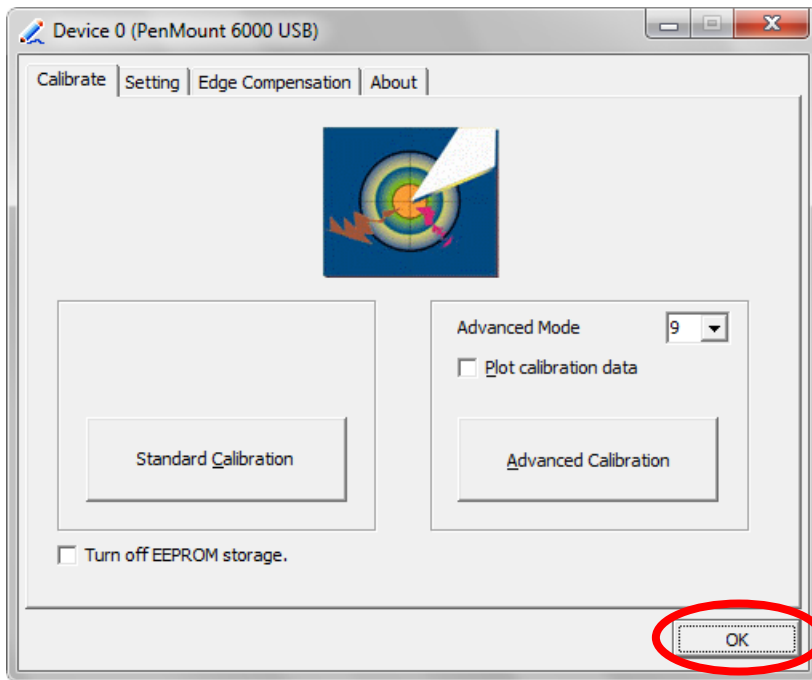

7. The calibration is now complete and the PenMount Control Panel window is displayed. Select OK to close the application down. The PM icon will still be present in the system tray for quick configuration should your touch screen need recalibration.



**Do not write on the terminal display with ink pens or use other sharp objects that may damage the display.**

## Using the Programmable Keys

The DLI 8500P has 6 integrated function keys. Each of the keys is user configurable via the DLI KeyMon Utility. The keys can be assigned to perform executable applications or to Data Ltd. predefined functions. The predefined functions are as follows: F1 assigned to DLI On-Screen Keyboard and F2 assigned to DLI Camera.

The DLI KeyMon utility can be launched from the system tray or from the **Start>Programs>DLI>DLI KeyMon**. The procedure below will assist you in defining the keys.

1. Double tap on the DLI KeyMon icon in the system tray



2. The DLI KeyMon screen is presented. Choose a key that requires a definition by tapping on the orange keys or by highlighting the key in the button assignment area and then double tapping.

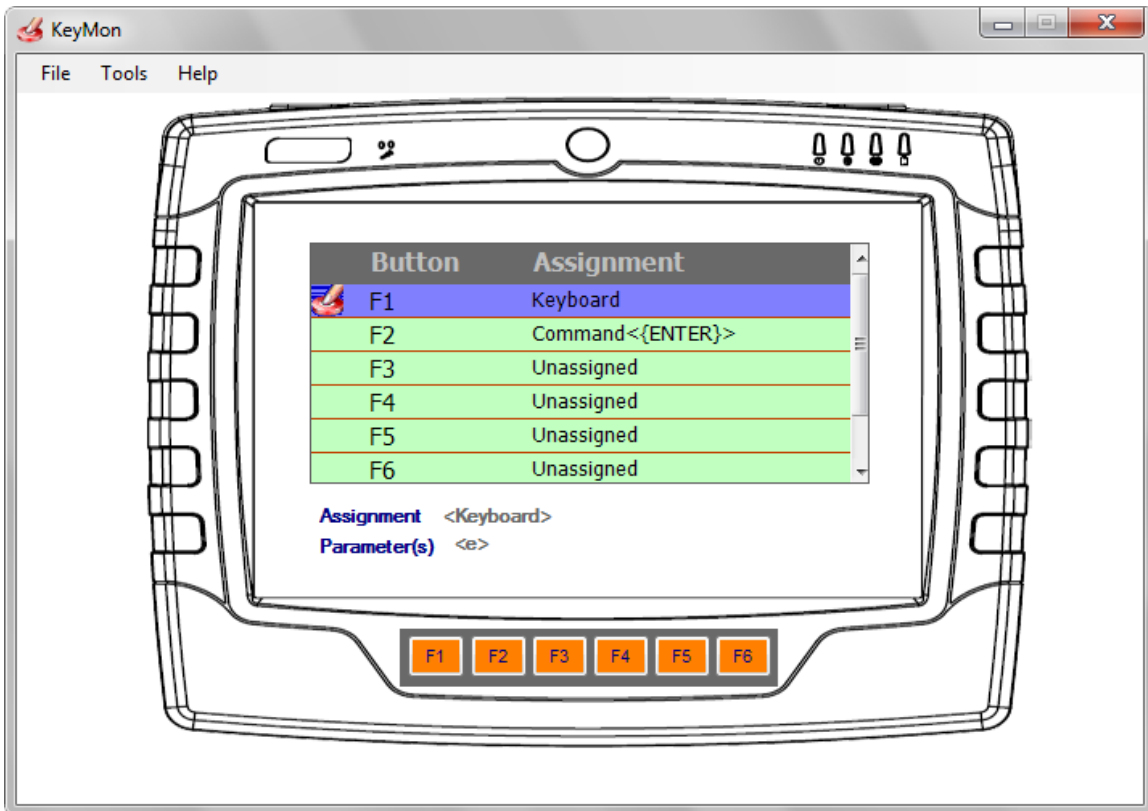

3. There are 5 options for key assignment. Choose an assignment type that is required for the key. Unassigned, Keyboard(OSK), Command, Scanner, External Program.
4. To assign an application choose **External program** and tap on the browser icon. (See page. 17)

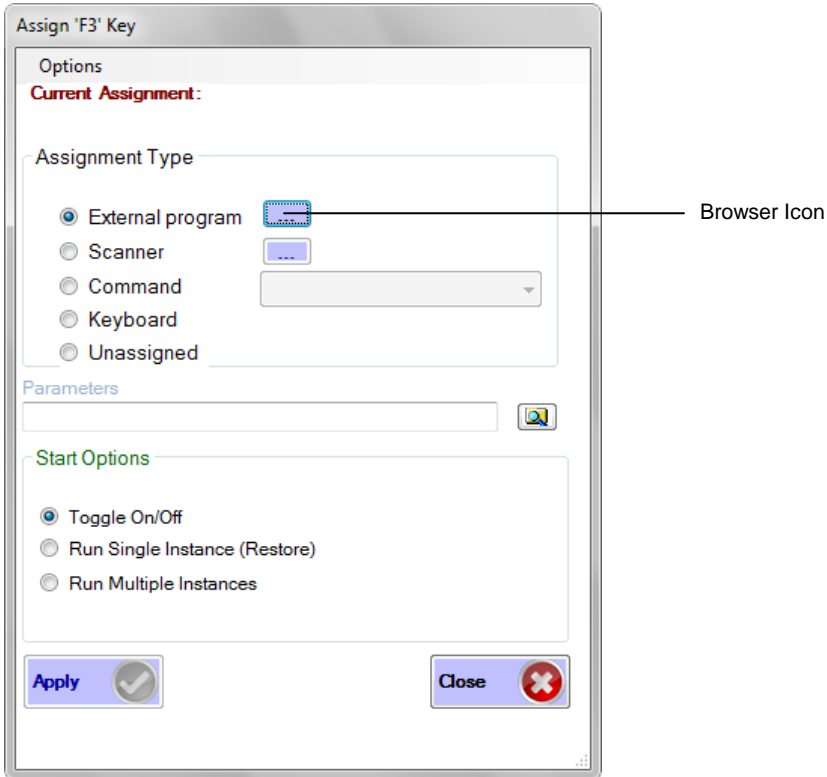

5. The user is returned to the assign menu once the selection has been chosen from the browser icon. Selecting the apply button saves the change to the key. The path to the application will appear in blue below the Current Assignment:

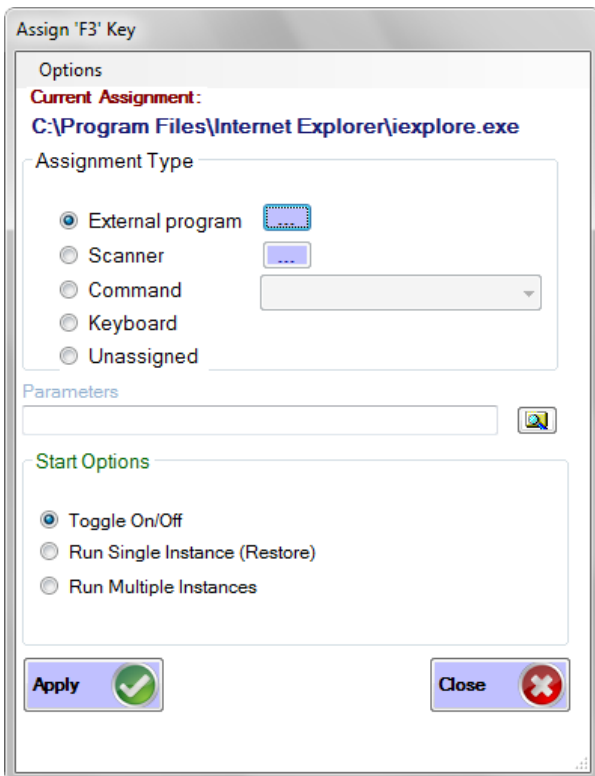

- To select a predefined action or keystroke choose **Command** and tap the down arrow to display a drop menu.

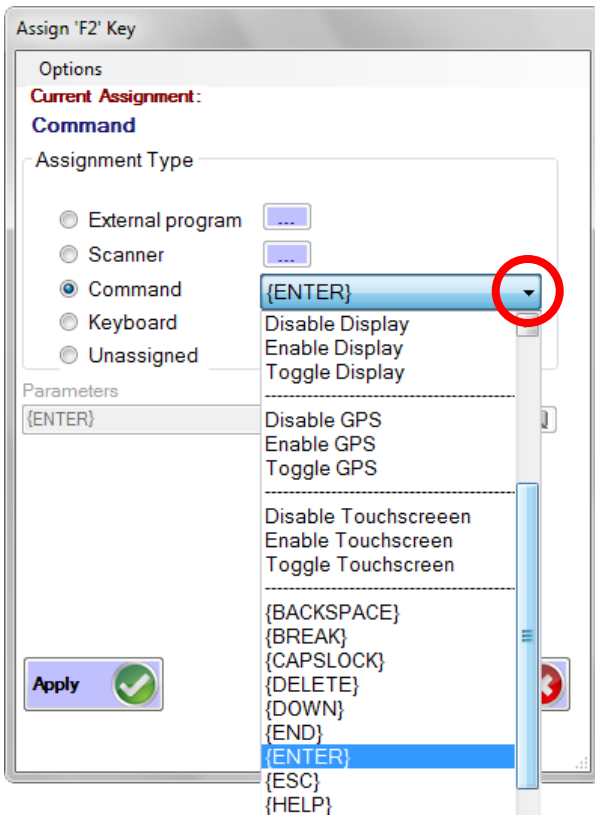

- The drop menu has a list of various actions and keystrokes to choose from. Once you have selected the command, tap the apply button to save.

- To Close the DLI KeyMon tap on the "X" on the top right of the Main Window.

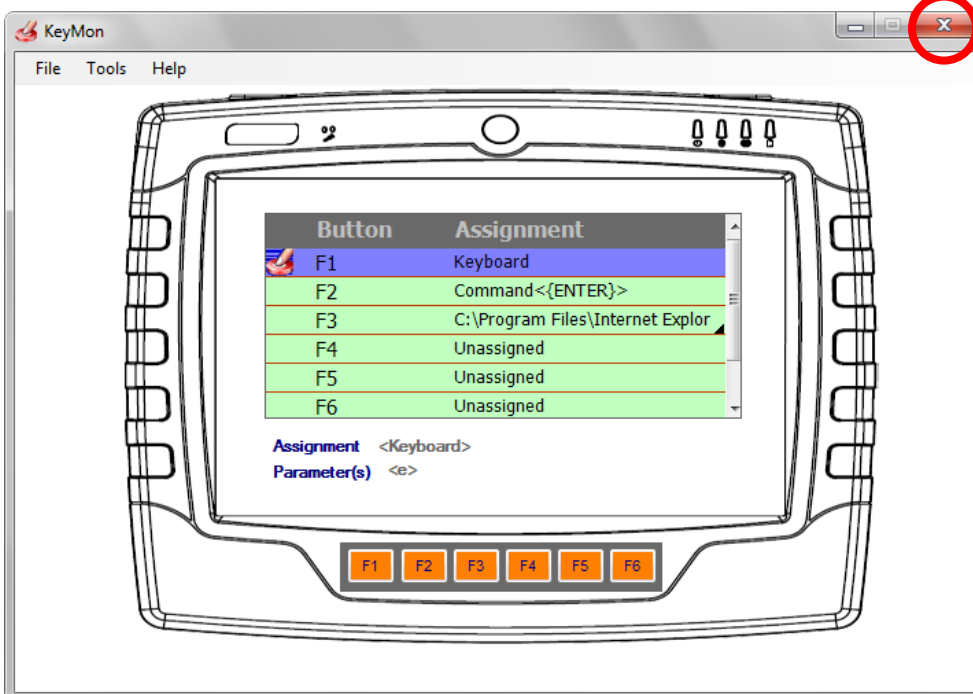

## Using the WiFi Radio

The DLI 8500P has a PCIe 802.11a/b/g/n integrated radio. In Windows 7 the radio is configured using the Windows Network and Sharing Center. With older versions of Windows the radio is configured by Intel PROSet. Please contact Technical Support (See page 29) if you have any questions configuring your radio. Windows provides the following features to Administrators and end-users:

- Connect or disconnect.
- View Available Networks and network mapping.
- Setup a new connection or network- Wireless, Wired, VPN connection or set up a router or access point.
- Connect and set up to a domain or homegroup.
- View Signal Quality and Speed.
- Troubleshoot problems – Diagnose and repair network programs, or get troubleshooting information.

### Intel PCIe Integrated Radio

- The Network icon can be found in the task tray. It provides a graphical representation of your connection or signal quality.



- Tap the network icon on the taskbar to see all your wireless and wired options—Wi-Fi, mobile broadband, dial-up, or corporate VPN. One more tap, and you're connected.

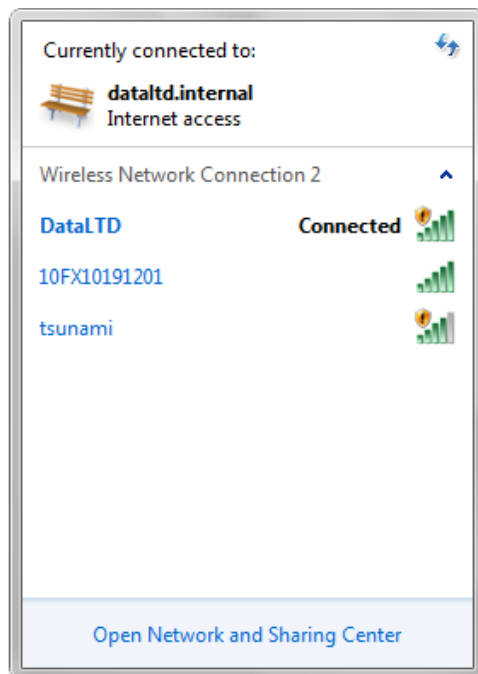

- Selecting Open Network and Sharing Center will bring you to the window below. Here you can view your Network Map, your Active Networks, your Connection types and info. You can also set up new connections or networks. Enter a domain or homegroup and edit sharing options.

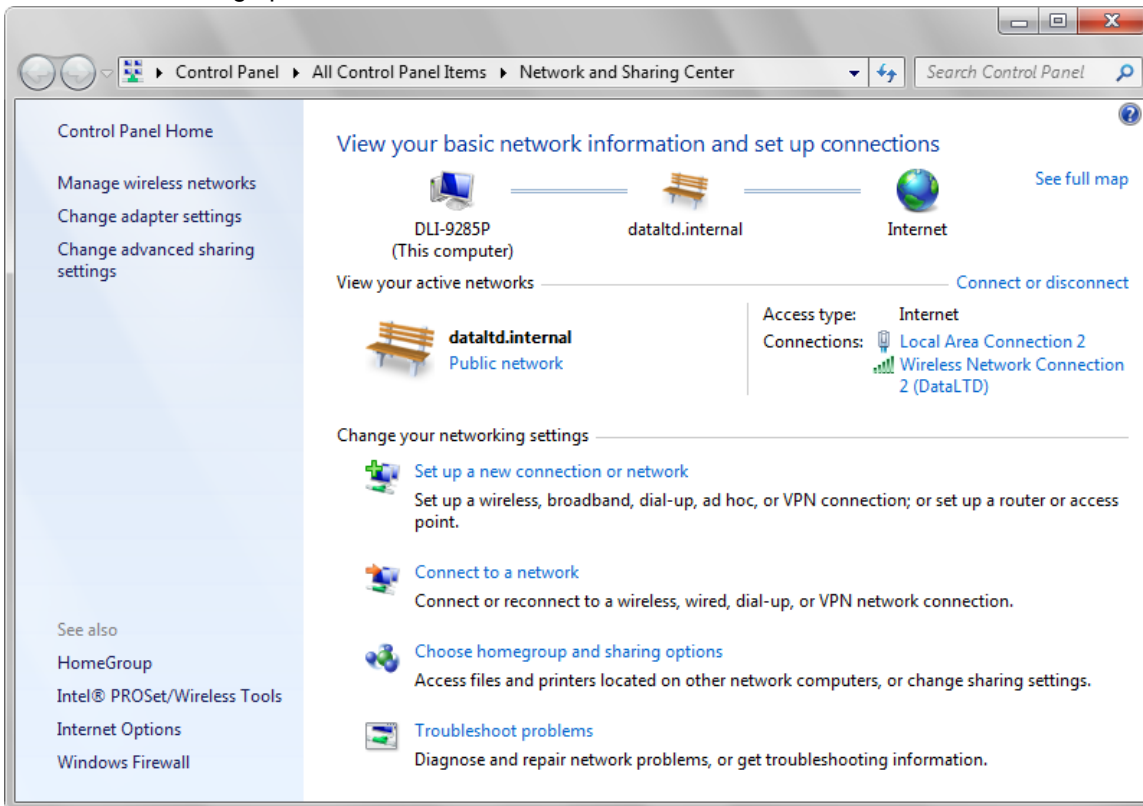

- Selecting Set Up a Connection or Network brings up an easy to use wizard that helps create a connection to your network and or the Internet. Choose the option that fits what you need to do.

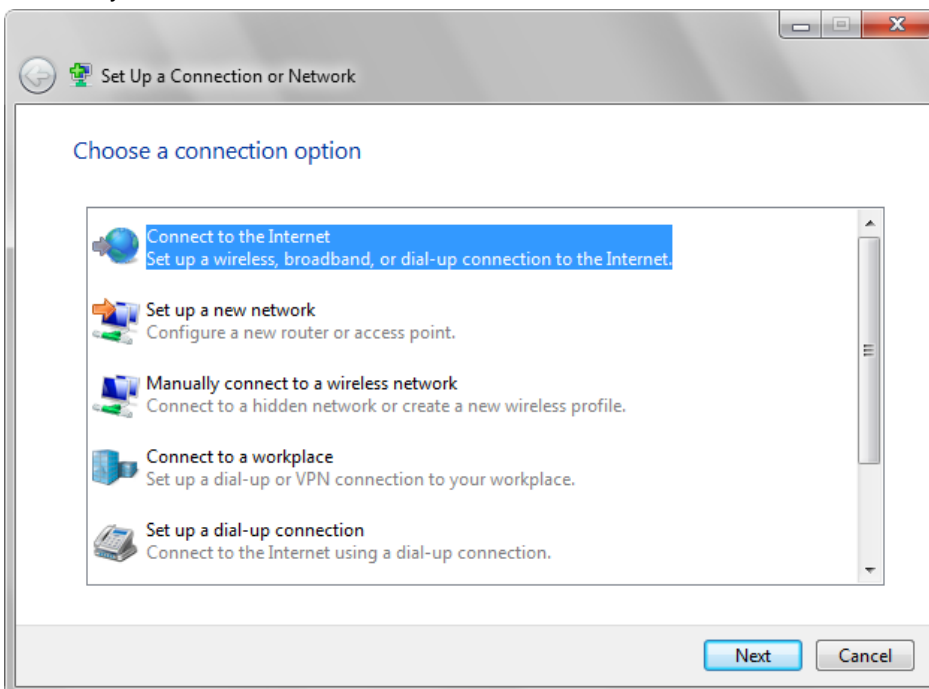

- If the SSID is not broadcasted you will need to select 'Manually connect to a wireless network'. This option will allow to you create a profile to add the SSID, Security type, and Encryption type. Select Next to connect.

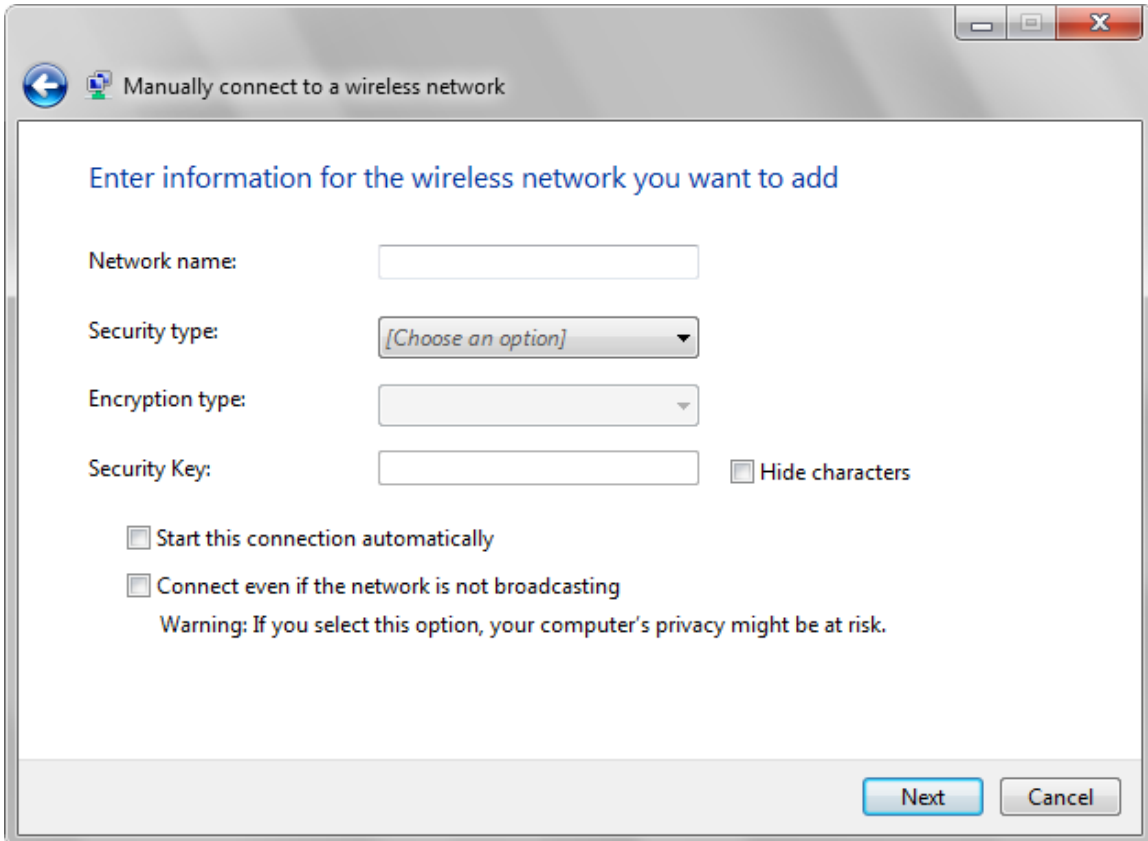

The screenshot shows a Windows dialog box titled "Manually connect to a wireless network". The dialog box has a standard Windows window title bar with minimize, maximize, and close buttons. Inside the dialog, there is a blue header bar with a back arrow icon and the title. Below the header, the text "Enter information for the wireless network you want to add" is displayed in blue. The form contains the following fields and options:

- Network name:** A text input field.
- Security type:** A dropdown menu with the text "[Choose an option]".
- Encryption type:** A dropdown menu.
- Security Key:** A text input field with a "Hide characters" checkbox to its right.
- Start this connection automatically
- Connect even if the network is not broadcasting

Below the second checkbox, there is a warning message: "Warning: If you select this option, your computer's privacy might be at risk." At the bottom right of the dialog, there are two buttons: "Next" and "Cancel".

## Using the Bluetooth Radio

The internal Bluetooth Class II wireless radio in the DLI 8500P is enabled by default. Microsoft™ Bluetooth software comes pre-installed on your terminal.

### Pairing an Accessory to the DLI 8500P

To pair a Bluetooth device to the DLI 8500P the icon in the system tray offers shortcuts to the Bluetooth Settings window; the Bluetooth File Transfer Wizard and the Add New Connection Wizard. Press and hold the stylus on the Bluetooth icon to open the Bluetooth device menu.

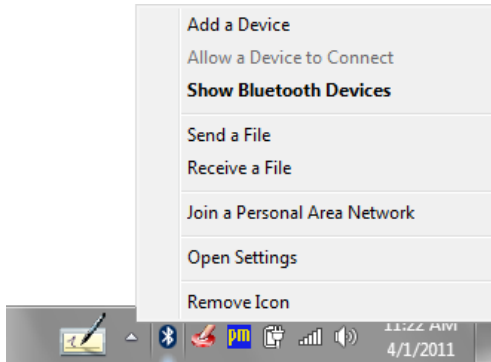

The following process is generally common for connecting most Bluetooth devices (keyboard, mouse, printer, cellular phone, PDA, Tablet PC, notebook PC, etc.). The actual steps may be slightly different for every type and brand of Bluetooth device. Read and follow the installation instructions included with your specific device. These are the four generic steps for connecting to a Bluetooth device.

1. Discover
2. Search
3. Pair
4. Connect

### Discover

Making a Bluetooth device discoverable makes it visible to other Bluetooth devices. Each Bluetooth device uses a different method (pressing a button or key combination) to make it discoverable. This is generally described in the device's documentation. When you activate Bluetooth on your Tablet PC it is the signal for the Tablet PC to look for, or discover any Bluetooth devices within range.

### Search

This process will find every Bluetooth device *that is discoverable and available for connection* within 33 feet (10 meters).

### Pair

Using a passkey creates a secure connection (pairing) between the Tablet PC and Bluetooth device. This passkey helps prevent data from being intercepted and interpreted by another device.



*Though the passkey exchange helps to secure your data, Bluetooth wireless technology should not be considered completely secure.*

### Connect

The first time a Bluetooth device is connected to the terminal the drivers are loaded for that device. After this initial connection, some Bluetooth devices may disconnect when they go into power-saving mode. Most will automatically reconnect when they become active again.

### Using the Bluetooth Application

1. Make sure that either the Bluetooth indicator light is flashing or that there is a checkmark beside **Enable Internal Bluetooth Wireless Radio** (both indicate that Bluetooth is running)
2. Using your stylus, Right mouse click the **Bluetooth Devices** icon in the system tray.
3. Tap **Add a Bluetooth Device** to launch the Bluetooth **Add Bluetooth Device Wizard**.

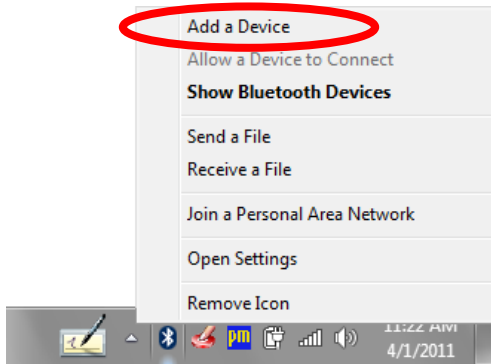

4. Place the Bluetooth device (headset, keyboard, printer, etc.) in discoverable mode.



*Each Bluetooth device may have a different way to make it discoverable. Some have a small button on the headset or keyboard; others may require that you press a key sequence to invoke discovery. Look at the documentation that came with the Bluetooth device or visit the manufacturer's website for information.*

5. After you make the Bluetooth device discoverable, it will show up in the wizard. Select the Bluetooth device and select Next.

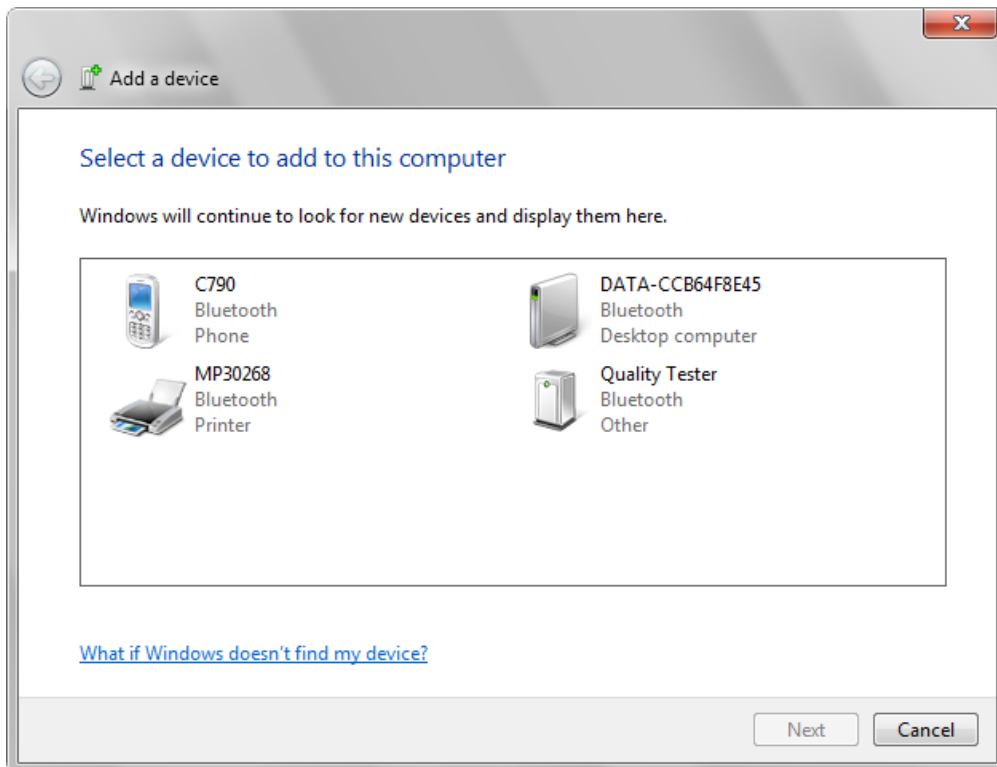

6. Select the pairing option that best works for your Bluetooth device. This option will vary per device. You have a limited time after selecting Enter the device's pairing code to input the code. Select Next.

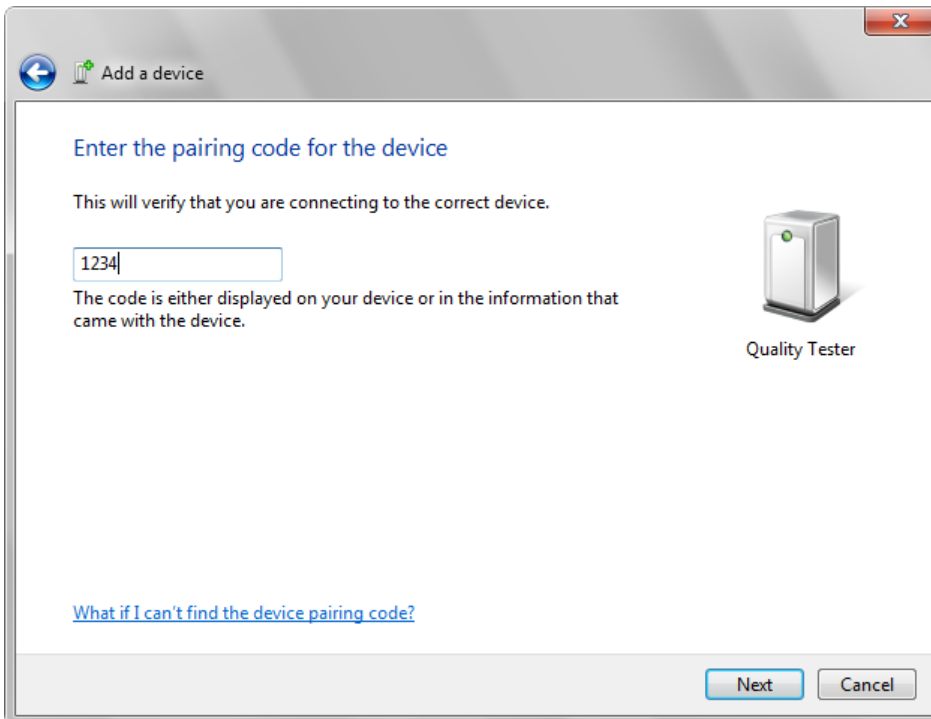
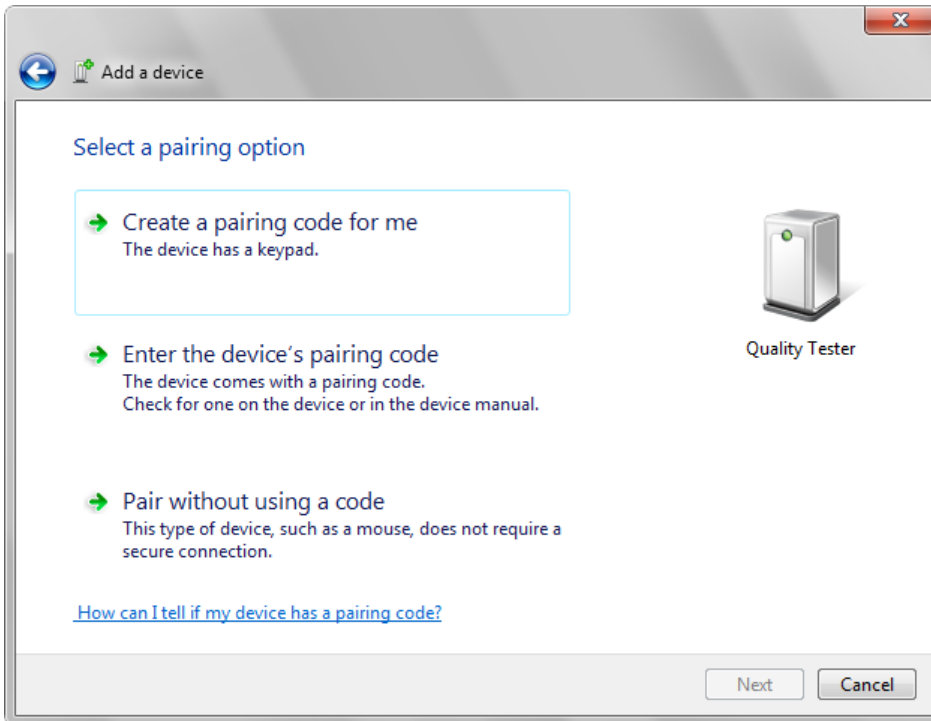

*If a pairing code is required, please read documentation that came with your Bluetooth device or contact the manufacturer.*

7. When the device has been successfully paired and added the wizard is complete and the device is ready to use. Select Close to finish

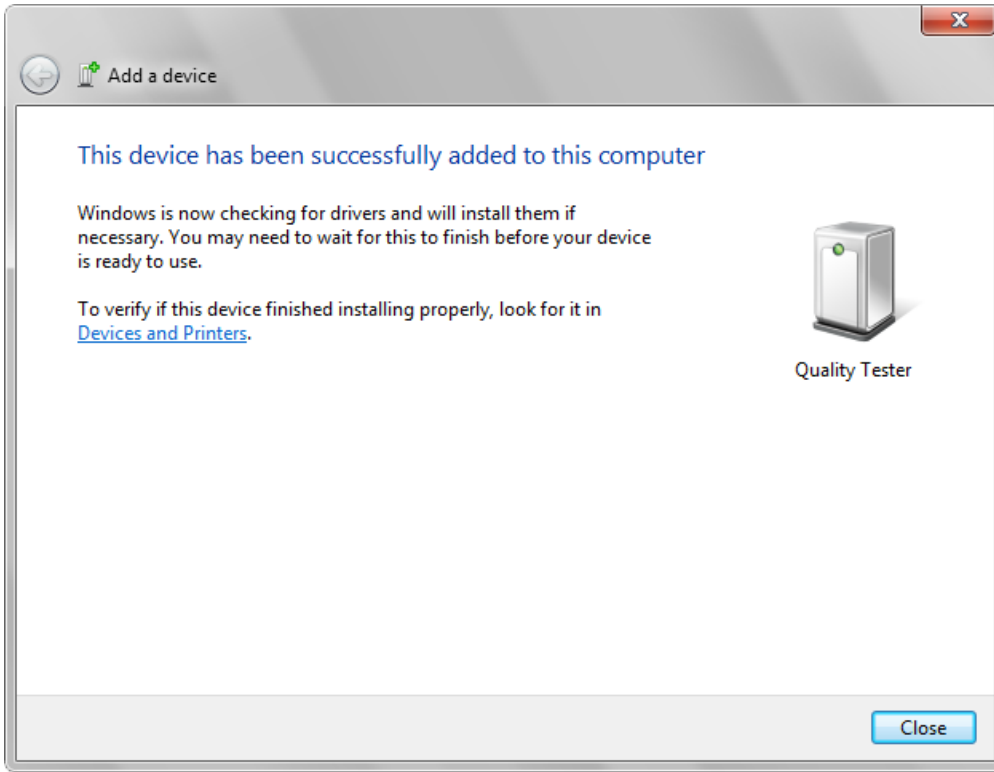

## Using the Camera Option

The 2M Pixel Color Camera is located on the front side of the terminal. The camera can be used for picture capture as well as streaming video.

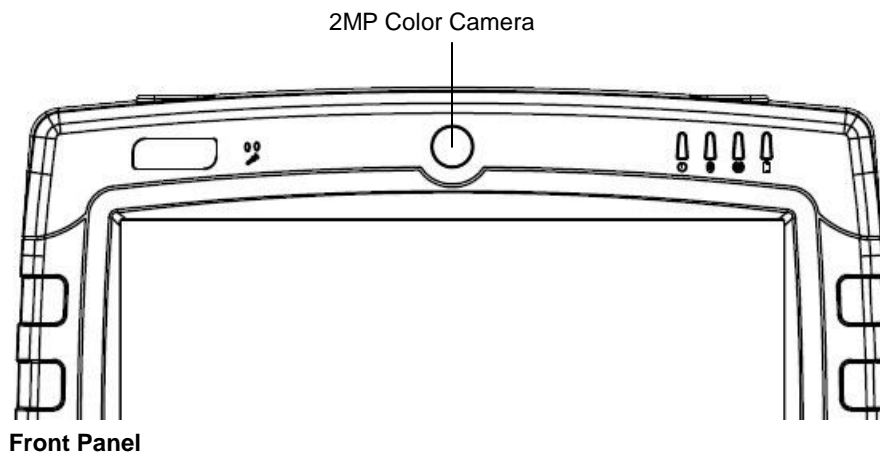

To verify the operation of the camera you will need to launch the DLI Camera Demo  
 To launch the application tap **Start>Control Panel>DLI Camera Demo** icon.



Tap Ok at the Stream Format Properties. The camera will auto focus to the image you chose to capture. By default the streaming resolution is set to 320X240. Tapping on the **Grab** button will capture the picture. The **Save** button provides the ability to save the picture to a desire location.

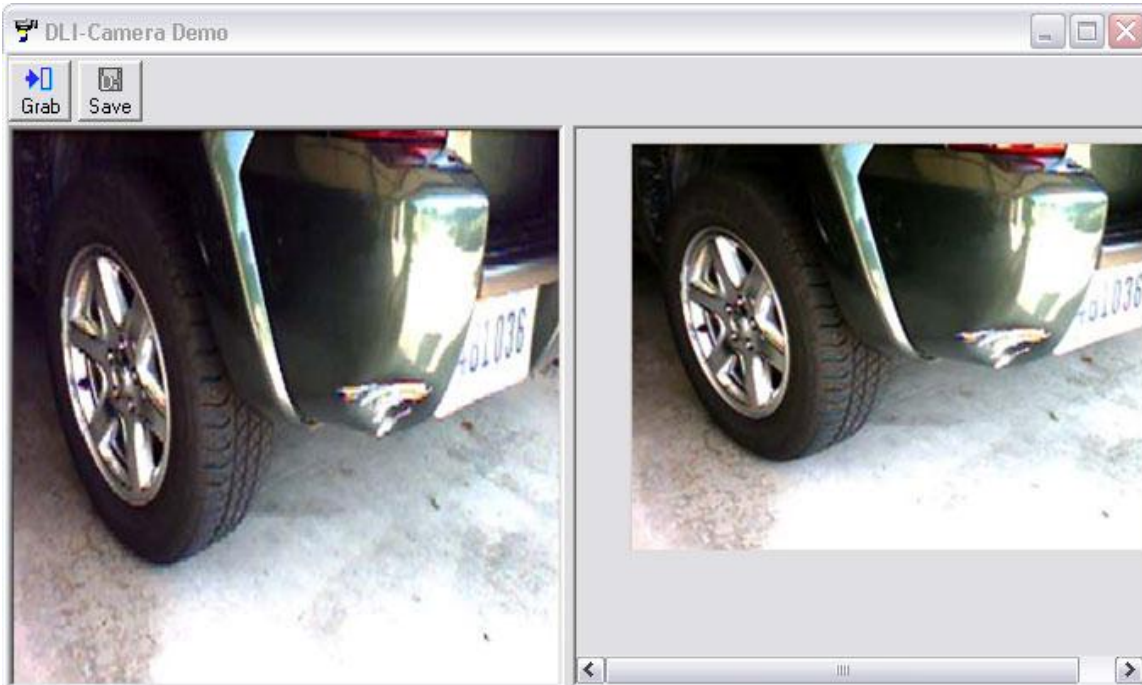

## Using the RS-232 DB9M

The integrated RS-232 Port can be configured to work with many peripherals including Barcode Scanners, Printers, ODBII (Vehicle Interface), and Remote Monitoring apparatuses. To configure the RS-232 port so that the data is sent to the keyboard buffer the following procedure is required. This procedure is typically used when using an external barcode scanner on the device.



**All DLI Devices have power to Pin 9.  
 DO NOT plug-in or unplug any serial devices while the DLI Device is powered on!**

**Bottom Panel**

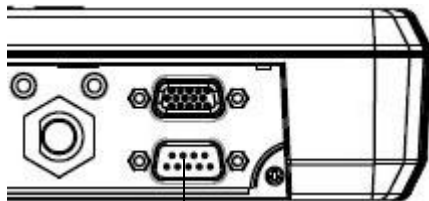

Serial Port

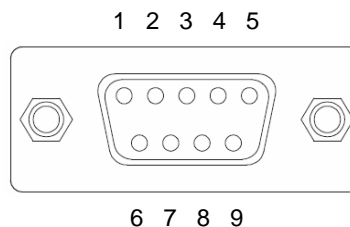

Pin	Description
1	DCD
2	TXD
3	RXD
4	DSR
5	GND
6	DTR
7	CTS
8	RTS
9	+5V

## Using the GPS

The optional GPS module with active antenna provides the SiRFstar III chip set and TTFF (Time to First Fix) technology which speeds the time to lock to a satellite. The Geohelix active antenna provides 25db gain. Along with each of these features Data Ltd's patent pending RF antenna switching technology provides you with the functionality of switching between external and internal antennas without software requirements.

Data Ltd has included in the DLI 8500P a GPS software tool to verify that all functions of the GPS module are working properly.

1. To launch the application tap on the **GPS** icon on the DLI 8500P desktop.



*Connectec GPS Monitor can also be found under C:\Program Files\DLI*

2. Set the COM Port to COM 3. This is the COM port that your GPS module is using. Set the Baud Rate to 9600. Next, tap the **Connect** button.

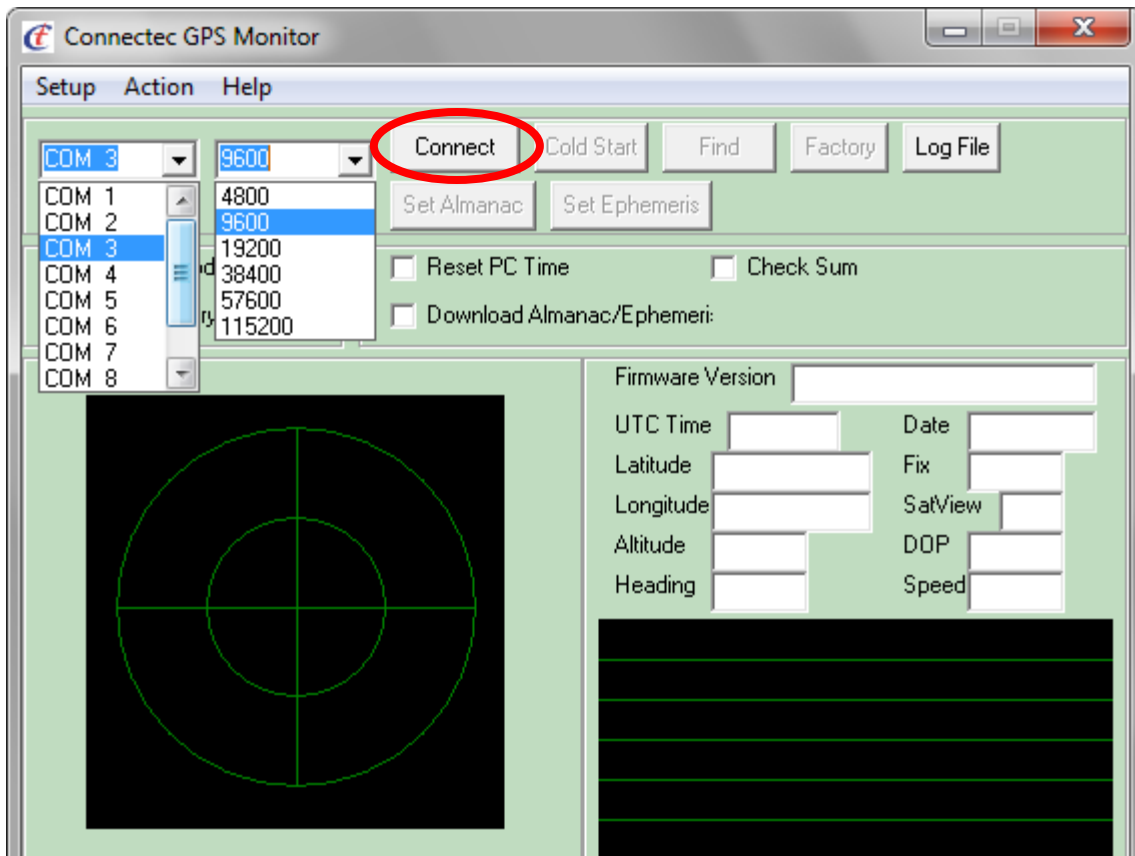

- Once connected you can verify the Signal Quality, Satellite Location, Latitude, Longitude and Altitude. You can also view the Streaming NMEA data. You must be outside a building as GPS antennas do not work inside buildings.



The green bars indicate a lock to a satellite.

## Installing Clearance & Airflow

Mounted to the back panel is a RAM-202U ball. Optional RAM mounting arms are available for a variety of secure options. Ask your Salesperson for more information on RAM Mounts. When selecting a location to mount the device, keep in mind that the power supply, RF connectors, and I/O are located on the bottom panel.



**Please ensure that you give a minimum of 2.75 inches of clearance from the base of the unit. Proper cable routing and clearance will help with less strain on cables and connectors, while also allowing for better access to the ports.**



**Please ensure the device is mounted at all times and not laid down on the back panel. Make sure the device is given a minimum of 1.5 inches of clearance to allow for proper airflow.**

## Integrated Power Filtering DC Converter

The DLI 8500P has an Integrated Backup Battery with 10–60V DC/DC Converter. **The DLI 8500P must be installed post ignition with a 10AMP in-line fuse.**

DC Converter: 10–60V Input	
Black	Ground
White	Positive
Yellow	Case Ground



**Please consult your fork truck manufacturer for proper installation instructions. DO NOT connect power to the hydraulics!**

## Technical Assistance

If you need assistance installing or troubleshooting, please call your Distributor or the Data Ltd. Inc. Technical Support Office.

North America/Canada:

Telephone: (800) 526-1299, Ext 774 (8 AM to 4 PM CST)

Fax number: (219) 362-1937

E- mail: [support@data ltd.com](mailto:support@data ltd.com)

Website: <http://www.data ltd.com/html/support-ticket.html>

## Product Service and Repair

Data Ltd. Inc. provides service for all its products through service centers throughout North America. To obtain warranty or non-warranty service, return the unit to Data Ltd. Inc. (postage paid) with a copy of the dated purchase record attached. Contact the appropriate location below to obtain a Return Material Authorization number (RMA #) before returning the product.

Telephone: (800) 526-1299 ext 723

Fax number: (219) 362-1937

E-mail: [RMA@data ltd.com](mailto:RMA@data ltd.com)

Website: <http://www.data ltd.com/html/request-rma.html>

## Shipping your DLI Device

### Proper way to pack your DLI device



**DO NOT ship any DLI Device without a proper UPS or FedEx container. The DLI Container is not meant for stand-alone shipping.**

- Place device in foam cover as shown.



- Place the wrapped DLI device in the correct position in the spacer inside the DLI Container.



- Using a proper UPS or FedEx container, line the bottom with Bubble Wrap, Air Pillows, Packing Foam, etc.



*The dimensions of the box shown are 27x17x10.*

- Fill the rest of the Shipping Container with packing material.



- Place the closed DLI container inside the lined Shipping Container.



- Seal the Shipping Container and ship to:  
Data LTD  
703 Data Ltd Parkway  
La Porte, IN 46350



## Limited Warranty

Data Ltd. Inc. warrants its products to be free from defects in materials and workmanship and to conform to Data Ltd. Inc. published specifications applicable to the products purchased at the time of shipment. This warranty does not cover any product which is (i) improperly installed or used; (ii) damaged by accident or negligence, including failure to follow the proper maintenance, service, and cleaning schedule; or (iii) damaged as a result of (A) modification or alteration by the purchaser or other party, (B) excessive voltage or current supplied to or drawn from the interface connections, (C) static electricity or electro-static discharge, (D) operation under conditions beyond the specified operating parameters, or (E) repair or service of the product by anyone other than Data Ltd. Inc. or its authorized representatives.

This warranty shall extend from the time of shipment for the duration published by Data Ltd. Inc. for the product at the time of purchase ("Warranty Period"). Any defective product must be returned (at purchaser's expense) during the Warranty Period to Data Ltd. Inc.'s factory or authorized service center for inspection. No product will be accepted by Data Ltd. Inc. without a Return Materials Authorization, which may be obtained by contacting Data Ltd. Inc. In the event that the product is returned to Data Ltd. Inc. or its authorized service center within the Warranty Period and Data Ltd. Inc. determines to its satisfaction that the product is defective due to defects in materials or workmanship, Data Ltd. Inc., at its sole option, will either repair or replace the product without charge, except for return shipping to Data Ltd. Inc..

EXCEPT AS MAY BE OTHERWISE PROVIDED BY APPLICABLE LAW, THE FOREGOING WARRANTY IS IN LIEU OF ALL OTHER COVENANTS OR WARRANTIES, EITHER EXPRESSED OR IMPLIED, ORAL OR WRITTEN, INCLUDING, WITHOUT LIMITATION, ANY IMPLIED WARRANTIES OF MERCHANTABILITY OR FITNESS FOR A PARTICULAR PURPOSE.

DATA LTD. INC'S RESPONSIBILITY AND PURCHASER'S EXCLUSIVE REMEDY UNDER THIS WARRANTY IS LIMITED TO THE REPAIR OR REPLACEMENT OF THE DEFECTIVE PRODUCT.

IN NO EVENT SHALL DATA LTD. INC. BE LIABLE FOR INDIRECT, INCIDENTAL, OR CONSEQUENTIAL DAMAGES, AND, IN NO EVENT, SHALL ANY LIABILITY OF DATA LTD. INC'S ARISING IN CONNECTION WITH ANY PRODUCT SOLD HEREUNDER (WHETHER SUCH LIABILITY ARISES FROM A CLAIM BASED ON CONTRACT, WARRANTY, TORT, OR OTHERWISE) EXCEED THE ACTUAL AMOUNT PAID TO DATA LTD. INC. FOR THE PRODUCT. THESE LIMITATIONS ON LIABILITY SHALL REMAIN IN FULL FORCE AND EFFECT EVEN WHEN DATA LTD. INC. MAY HAVE BEEN ADVISED OF THE POSSIBILITY OF SUCH INJURIES, LOSSES, OR DAMAGES. SOME STATES, PROVINCES, OR COUNTRIES DO NOT ALLOW THE EXCLUSION OR LIMITATIONS OF INCIDENTAL OR CONSEQUENTIAL DAMAGES, SO THE ABOVE LIMITATION OR EXCLUSION MAY NOT APPLY TO YOU.

All provisions of this Limited Warranty are separate and severable, which means that if any provision is held invalid and unenforceable, such determination shall not affect the validity of enforceability of the other provisions hereof.

Data Ltd. Inc., Inc. extends these warranties only to the first end users of the products. These warranties are non-transferable.

The limited duration of the warranty for the DLI 8500P is as follows:

- DLI 8500P terminal with the integrated modules are covered by a one-year limited warranty.
- Touch screens are covered by a one-year limited warranty.
- The limited duration of the warranty for batteries is one year. Use of any battery not sold/ manufactured by Data Ltd. Inc. may damage the terminal and/or the battery and will void the warranty. Batteries returned to Data Ltd. Inc. in a reduced state may or may not be replaced under this warranty. Battery life will be greatly increased when following the battery instructions in the DLI 8500P User's Guide.
- Use of any peripheral not manufactured/sold by Data Ltd. Inc. will void the warranty. This includes but is not limited to: cables, power supplies.

## Regulatory and Safety Approvals for the DLI 8500P

DLI 8500P terminal meets or exceeds the requirements of all applicable standards organizations for safe operation. However, as with any electrical equipment, the best way to ensure safe operation is to operate them according to the agency guidelines that follow. Please read these guidelines carefully before using your DLI 8500P terminal.

### Embedded Safety Information Text

The DLI 8500P has the following safety information on the back label of the terminal



DLI 8500P RF terminal is designed to comply with the most current applicable standards on safe levels of RF energy developed by the Institute of Electrical and Electronics Engineers (IEEE) and the American National Standards Institute (ANSI) and has been recommended for adoption by the Federal Communications Commission (FCC).

The compliance labels are located on the back of the unit:

**DLI 8500P WPAN (Bluetooth)**

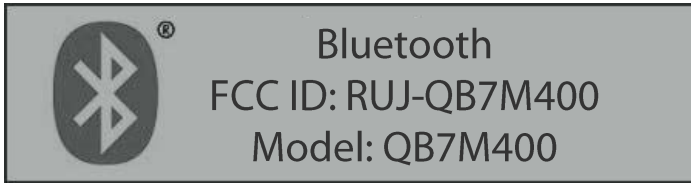

**DLI 8500P WWAN (CDMA Sierra Wireless Radio) Verizon®**

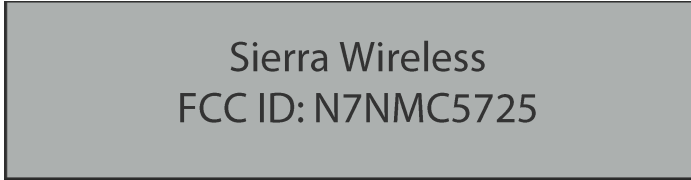

**DLI 8500P 802.11 B/G/N Radio**



**DLI 8500P GPRS**

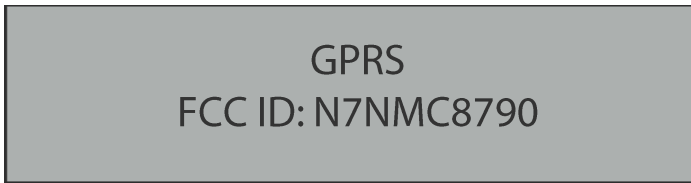

Parameter	Specification
U.S.A	FCC Part 15, Class B
Canada	ICES-003
European Community	EN 55022 (CISPR 22) Class B EN60950:2000 EN60825-1:1994 + A11 + A2 EN55024:1998

The CE Mark on the product indicates that the system has been tested to and conforms to the provisions noted within the 89/336/EEC Electromagnetic Compatibility Directive and the 73/23/EEC and 93/68/EEC Low Voltage Directive.

For further information, please contact:

Data Ltd. Inc.  
703 Data Ltd Parkway  
P.O. Box 761  
La Porte, IN 46352 USA  
(800) 526-1299

Data Ltd. Inc. shall not be liable for use of our product with equipment (i.e., power supplies, personal computers, etc.) that is not CE marked and does not comply with the Low Voltage Directive

## FCC Compliance

This device complies with Part 15 of the FCC Rules. Operation is subject to the following two conditions: (1) this device may not cause harmful interference, and (2) this device must accept any interference received, including interference that may cause undesired operation.

This equipment has been tested and found to comply with the limits for a Class B digital device pursuant to Part 15 of the FCC Rules. These limits are designed to provide reasonable protection against harmful interference in a residential installation. This equipment generates, uses, and can radiate radio frequency energy and, if not installed and used in accordance with the instructions, may cause harmful interference to radio communications. If this equipment does cause harmful interference to radio or television reception, which can be determined by turning the equipment off and on, the user is encouraged to try to correct the interference by one or more of the following measures:

- Reorient or relocate the receiving antenna.
- Increase the separation between the equipment and receiver.
- Connect the equipment into an outlet on a circuit different from that to which the receiver is connected.
- Consult the dealer or an experienced radio/TV technician for help.

If necessary, the user should consult the dealer or an experienced radio/television technician for additional suggestions. The user may find the following booklet helpful: "Something About Interference." This is available at FCC local regional offices. Our company is not responsible for any radio or television interference caused by unauthorized modifications of this equipment or the substitution or attachment of connecting cables and equipment other than those specified by our company.

The correction is the responsibility of the user. Use only shielded data cables with this system. In accordance with FCC 15.21, changes or modifications not expressly approved by the party responsible for compliance could void the user's authority to operate the equipment.



**This device and its antenna must not be co-located or operating in conjunction with any other antenna or transmitter. To maintain compliance with FCC RF exposure guidelines for body-worn operation, do not use accessories that contain metallic components.**

When using accessories where the terminal is worn on the body, the terminal's touch screen must face away from the body.

**CAUTION!** *Any changes or modifications not expressly approved by the grantee of this device could void the user's authority to operate the equipment.*

### **Canadian Compliance**

This Class B digital apparatus complies with Canadian ICES-003. Operation is subject to the following two conditions: (1) this device may not cause harmful interference, and (2) this device must accept any interference received, including interference that may cause undesired operation.

To prevent radio interference to the licensed service, this device is intended to be operated indoors and away from windows to provide maximum shielding. Equipment (or its transmit antenna) installed outdoors is subject to licensing.

Cet appareil numérique de la Classe B est conforme à la norme NMB-003 du Canada.

### **For European Community Users**

Data Ltd. Inc. complies with Directive 2002/69/EC OF THE EUROPEAN PARLIAMENT AND OF THE COUNCIL of 27 January 2003 on waste electrical and electronic equipment (WEEE).

#### *Waste Electrical and Electronic Equipment Information*

This product has required the extraction and use of natural resources for its production. It may contain hazardous substances that could impact health and the environment, if not properly disposed.

In order to avoid the dissemination of those substances in our environment and to diminish the pressure on the natural resources, we encourage you to use the appropriate take-back systems for product disposal. Those systems will reuse or recycle most of the materials of the product you are disposing in a sound way.



The crossed out wheeled bin symbol informs you that the product should not be disposed of along with municipal waste and invites you to use the appropriate separate take-back systems for product disposal.

If you need more information on the collection, reuses, and recycling systems, please contact your local or regional waste administration.

You may also contact your supplier for more information on the environmental performances of this product.



shipping: 703 data ltd parkway laporte, Indiana 46350  
mail: p.o. box 761 laporte, Indiana 46352  
toll free: 800.526.1299 · fax: 219.362.1932 · [www.data ltd.com](http://www.data ltd.com)

